

# 9704 ENDICOTT

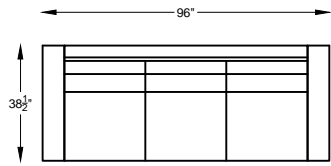

970499 LARGE SOFA

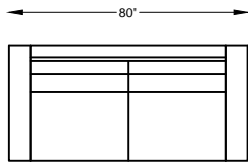

970420 SOFA

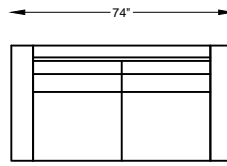

970413 LOVESEAT

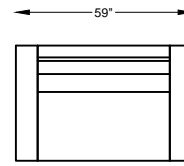

970486 CHAIR-1/2

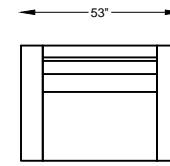

970404 CHAIR

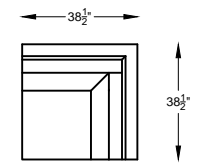

970405 CORNER CHAIR

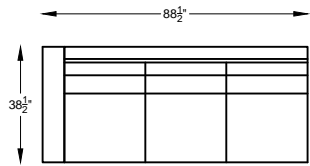

970498L or R ONE ARM LARGE SOFA  
\*SHOWN AS LEFT ARM

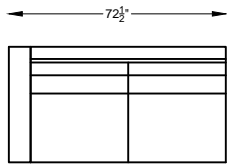

970417L or R ONE ARM SOFA  
\*SHOWN AS LEFT ARM

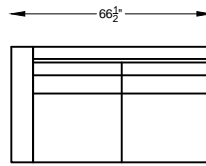

970410L or R ONE ARM LOVESEAT  
\*SHOWN AS LEFT ARM

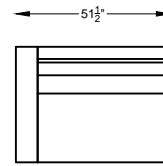

9704113L or R ONE ARM CHAIR 1-1/2  
\*SHOWN AS LEFT ARM

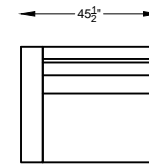

970403L or R ONE ARM CHAIR  
\*SHOWN AS LEFT ARM

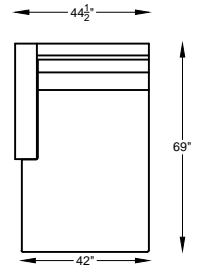

970407L or R ONE ARM CHAISE  
\*SHOWN AS LEFT ARM

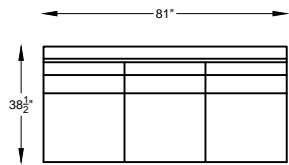

970497 ARMLESS LARGE SOFA

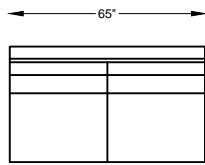

970414 ARMLESS SOFA

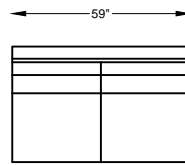

970409 ARMLESS LOVESEAT

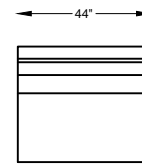

9704114 ARMLESS CHAIR-1/2



970402 ARMLESS CHAIR

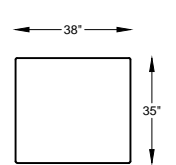

970401 OTTOMAN

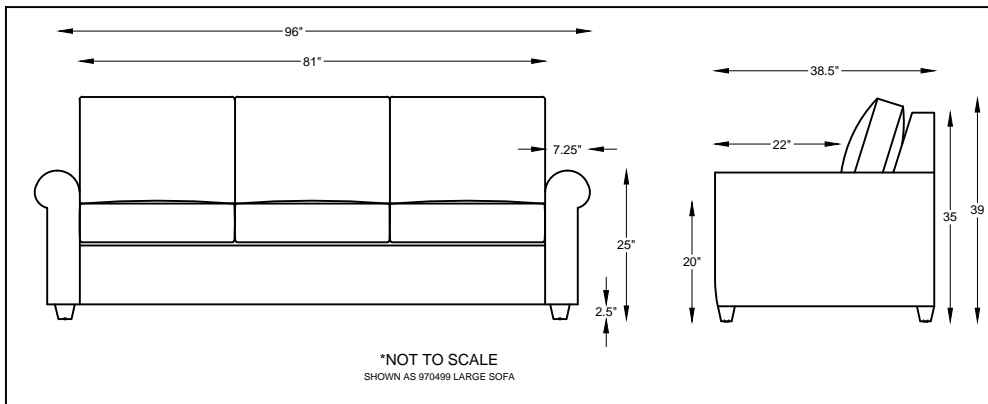

\*NOT TO SCALE  
SHOWN AS 970499 LARGE SOFA

"F" = FINISH LEG OPTION  
"C" = CHROME LEG OPTION

Scale: 3/16" = 1'-0"

This schematic is current as 02/017. The company reserves the right to change dimensions and products offered. A more recent schematic may be available for this series. To see the most current schematic, go to <http://lazarind.com>

\*NOTE: L or R IS DETERMINED BY FACING AT THE PIECE

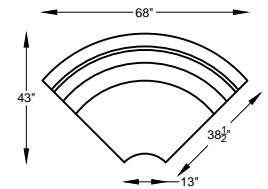

970423 WEDGE